

# SIRIUS CAPACITOR MODULE

## User Manual

Model number: 465-12-B-0.9C-TM-A-G

Version 1.0; Release Date: September 2019



Author:

Mamoona Khalid

## **Introduction**

The Sirius Capacitor Module (“Sirius”) is supercapacitor-based storage that uses supercapacitors as storage cells instead of chemical cells. Kilowatt Labs’ proprietary balancing, control and charge retention algorithms control the operation of the supercapacitor-based modules, making Sirius a safe, efficient and effective alternative to chemical batteries wherever chemical batteries are deployed.

## **Legal Provisions**

No part of this User Manual (“Manual”) may be reproduced, or transmitted, in any form or by any means, without the prior written permission of Kilowatt Labs, Inc. (“Kilowatt” or the “Company”). Specifications in this Manual are subject to change without notice. While every attempt has been made to make the Manual accurate and up-to-date, users are cautioned that product improvements may cause the Company to make changes to specifications without advance notice. Users are encouraged to consult the Company or its Resellers before using the Manual. Neither the Company nor its Resellers shall be liable for any indirect, incidental, or consequential damages under any circumstances caused by reliance on the material presented, including, but not limited to, omissions, typographical errors, arithmetical errors or listing errors in the content material. The content of this manual shall not be modified without the written authorization of the Company.

## **Trademarks**

All trademarks are recognized, even if not explicitly identified as such. Kilowatt Labs® is a registered trademark of the Company.

## Contents

1. Safety Instructions: .....	4
1.1 Symbols Convention: .....	4
1.2 Safety Precautions: .....	4
1.3 Modules Connection Safety Precautions: .....	5
1.4 Shipping: .....	6
1.5 Qualified Installer: .....	6
2. Product Introduction: .....	6
2.1 Product Part Number: .....	6
2.2 Product Overview: .....	7
2.2.1 Appearance: .....	7
2.2.2 Mechanical Drawings: .....	8
2.2.3 Dimensions and Weight: .....	10
2.3 Product Description: .....	10
3. Module Installation: .....	12
3.1 Inspection: .....	12
3.2 Safety Gear: .....	12
3.3 Unpacking and Contents Check: .....	13
4. Operation Procedures: .....	13
4.1 Module Configuration: .....	13
5. Connecting the Module in Parallel or in Series: .....	14
5.1 Parallel Connection of Sirius Modules: .....	14
5.2 Series Connection of Sirius Modules: .....	15
6. Automatic Safety Shutdown: .....	16
7. Trouble Shooting: .....	20
8. Features: .....	21
8.1 Key Features: .....	21
9. Shelf Life: .....	21
10. Maintenance: .....	21
11. Disposal: .....	21

## 1. Safety Instructions:

This manual contains instructions for unpacking, mounting, installation and operation of a Sirius Module. Please read this manual carefully before operating the system and follow all warnings and safety instructions to prevent accidents. The Sirius Module must be installed by trained personnel.

### 1.1 Symbols Convention:

Safety instructions and general information that appears in this manual are described.



**Caution!**

“Caution” indicates hazardous situation which, if not avoided could result in minor or moderate injury.



**Warning!**

“Warning” indicates hazardous situation which, if not avoided could result in major injury or death.



**Danger!**

“Danger” indicates hazardous situation which, if not avoided could result in serious injury or death.



**Note!**

‘Note’ provides tip that are valuable for optimal operation of your product.

### 1.2 Safety Precautions:

The Sirius Modules are designed to provide years of trouble-free operation. Proper handling is required to avoid damage to the Module. In particular the following precautions should be observed.

- **Personal Safety:**

- Always wear proper personal protective equipment (eyes protection, gloves and safety shoes).
- Always make sure charger is set as recommended.
- Always make sure chargers are disconnected while working on Modules.

- **Module Safety:**

- Do not subject the Module to strong impact.

- Do not crush or puncture the Module.
- Do not dispose the Module in a fire.
- Do not charge the Module when the temperature is below -30°C.
- Do not charge the Module when temperature is above 80°C.
- Do not operate the Module above the specified voltage.
- Under no circumstances charge/discharge the Module at more than 35A.
- Under no circumstance must the charging voltage exceed 13.5 V<sub>dc</sub> for more than 60 seconds.
- Do not expose the Module to temperatures in excess of 80°C.
- Do not place the Module near a heat source, such as a fireplace.
- Do not disassemble the Module under any circumstances.
- Do not touch the Module with wet hands.
- Do not expose the Module to moisture or liquids.
- Keep the Module away from children and animals.
- Ensure precautions to prevent short-circuit under all circumstances.
- Do not connect or disconnect terminals from the Module without first disconnecting the load.
- Do not touch the terminals with conductors while the Module is charged. Serious burns, shock, or material fusing may occur.
- Protect surrounding electrical components from incidental contact.
- When connecting to external devices ensure that galvanic isolation does not exceed 1000V.
- Do not use the Module in open-environment, in rain or in a place exposed to water and other liquids.
- Do not subject the Module to high pressure.
- It is not recommended to stack more than 3 Modules.
- Do not step on the Module.
- Do not drop the Module. Internal damage may occur that will not be visible.
- Do not stack Modules once they have been removed from the packaging, instead the Modules should be placed on shelving.
- In case the Module is physically damaged due to any event, do not install and energize the Module under any circumstances and immediately contact your Reseller.

### **1.3 Modules Connection Safety Precautions:**

- All Modules must be at 100% SOC before connecting in Series or in Parallel.
- The maximum number of Modules that can be connected in series is 35.

- Do not connect more than 35 Modules in Series.
- Modules cannot be connected in Series-Parallel combination under any circumstance.



**Note!**

If you want to connect more than 35 Modules in Series, please contact your Reseller.

**1.4 Shipping:**

Sirius Capacitor Modules are shipped out via Air and Sea.

- If the Modules are shipped via Air, please follow the instructions given below:
  - Carefully remove the nails from all the four sides of the wooden box and open it.
  - Remove the foam and shrink wrap and open the carton box and lift the Module manually.
- If the Modules are shipped via Sea, please follow the instructions below:
  - Carefully remove the Module from the pallets after cutting the packing strip holding the Modules to the shipping pallets.
  - Open the carton box and lift the Module manually.

**1.5 Qualified Installer:**

Selling and installation of this Module is only through the Company's Resellers who are trained on installation, operation and maintenance of the Sirius Modules.

**2. Product Introduction:**

**2.1 Product Part Number:**

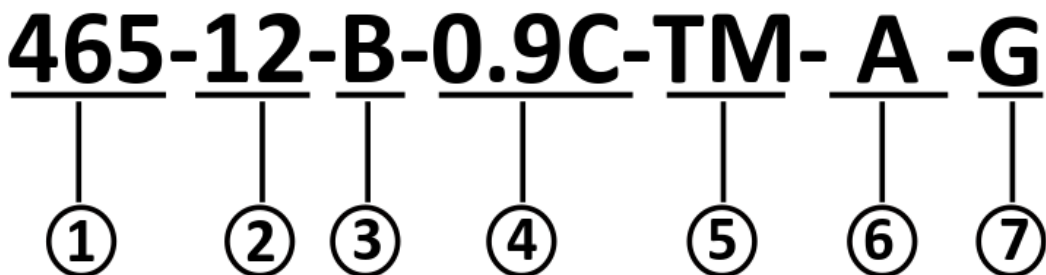

- 1) Capacity of Module in Wh
- 2) Nominal Voltage of the Module
- 3) Terminals are on the Front Side
- 4) Maximum Charge Rate of the Module
- 5) Total Monitoring
- 6) With Alarm
- 7) General Module

## 2.2 Product Overview:

### 2.2.1 Appearance:

The appearance of the Sirius Module is shown below:

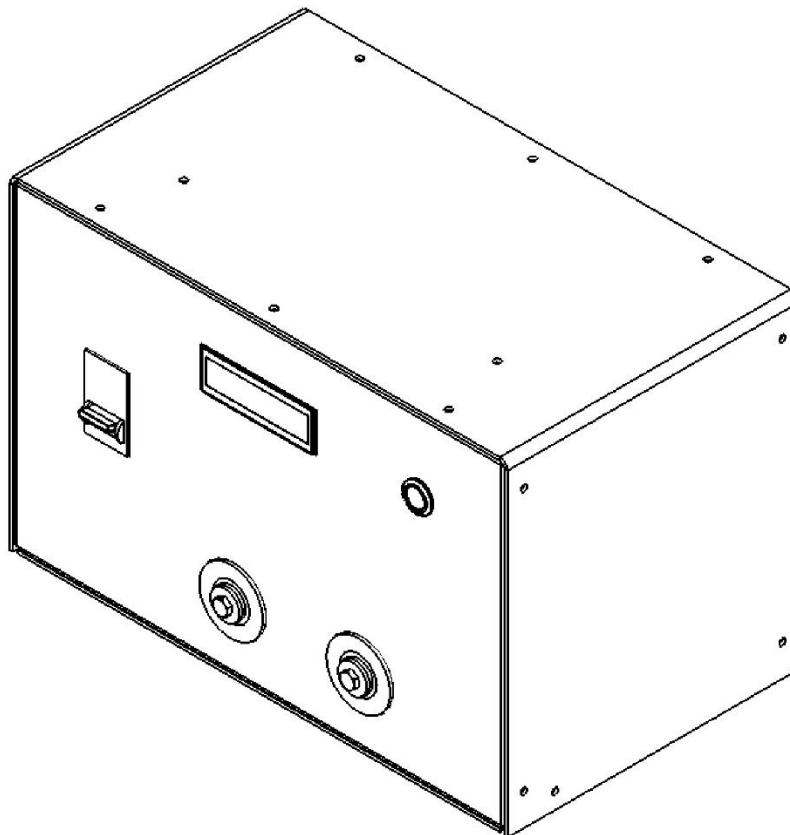
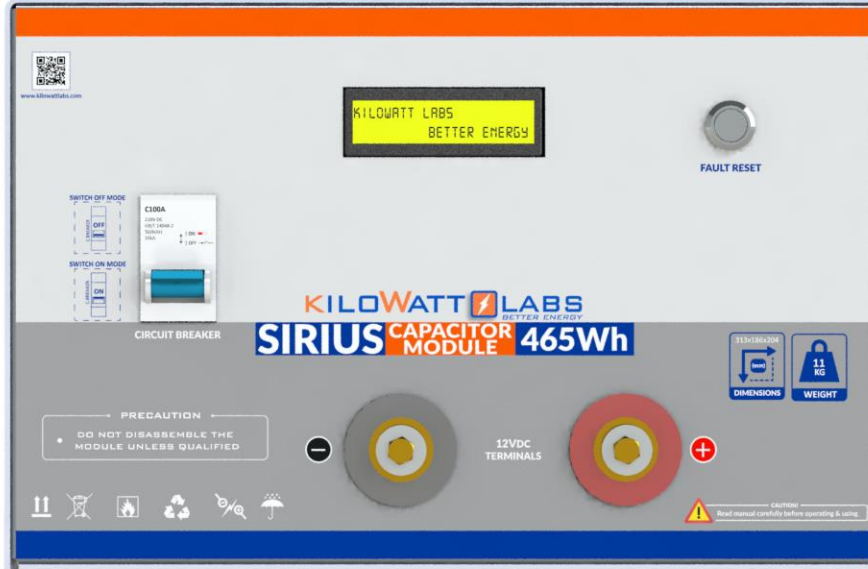

**2.2.2 Mechanical Drawings:**

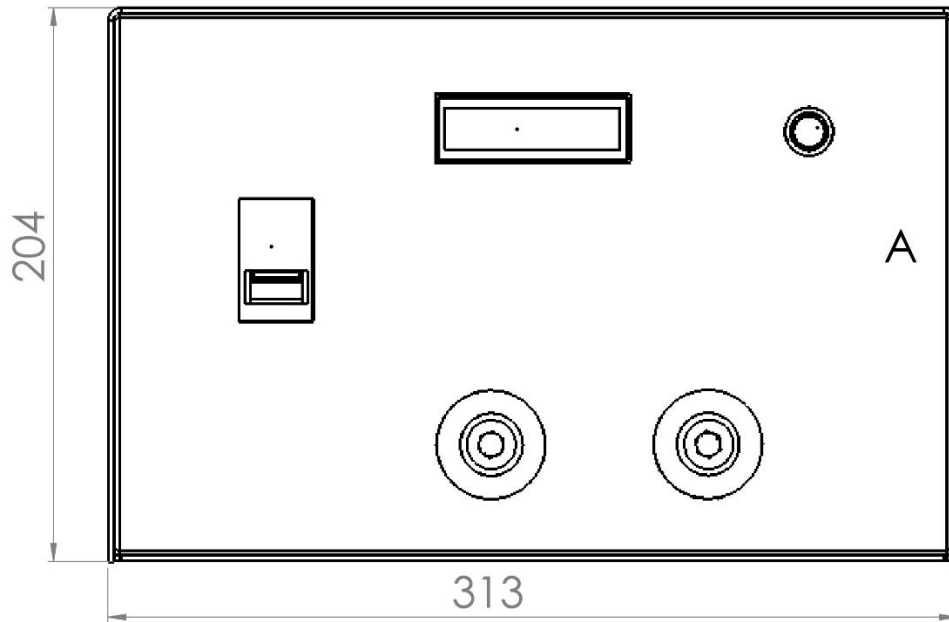

**Front View**

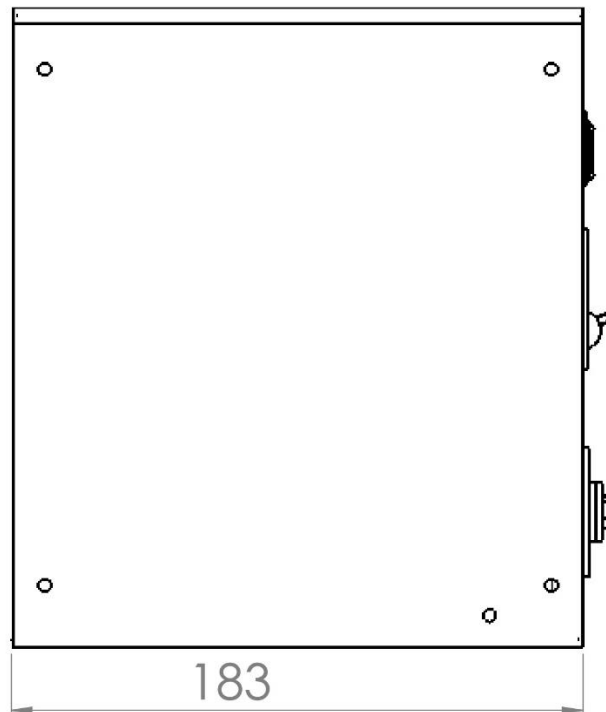

**Side View**



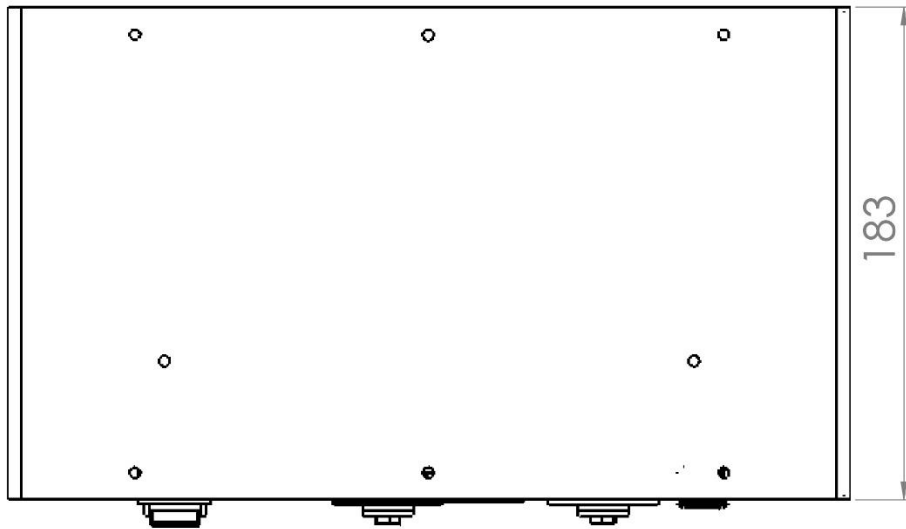

**Top View**

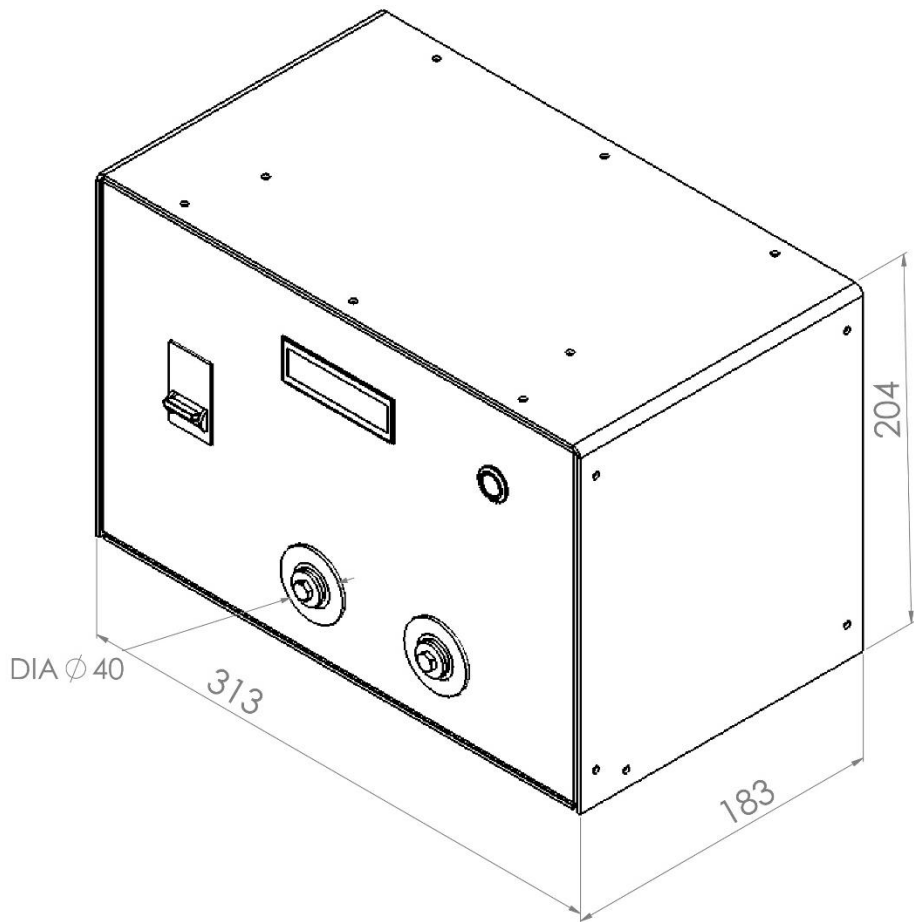

**Isometric View**

**2.2.3 Dimensions and Weight:**

Width	313 mm
Depth	183 mm
Height	204 mm
Weight	11 kg

**2.3 Product Description:**

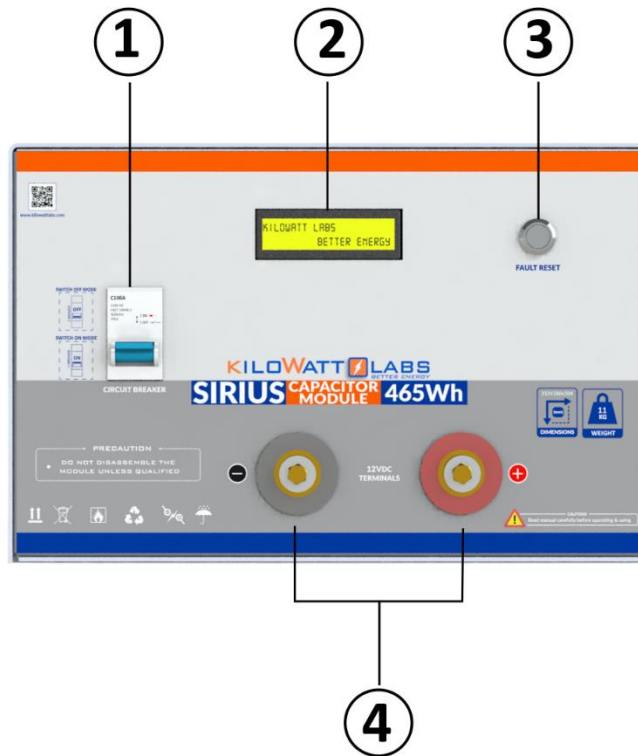

Object	Mark	Description
1	Circuit Breaker	C100A Circuit breaker for switch ON/OFF Module.
2	LCD	(16x2) LCD
3	Fault Reset	Fault Reset Button
4	F12 terminals	Terminals

**1. Circuit Breaker:**

Circuit breaker is used to power ON the Module. It also protects the Module from short circuit.



**Note!**  
Make sure that there are no external loads or charger before setting the current to zero.

**2. LCD Description:**

→ Once the power is switched ON from the circuit breaker, the Module gets power and the LCD shows the following message after 3 seconds under normal operation:

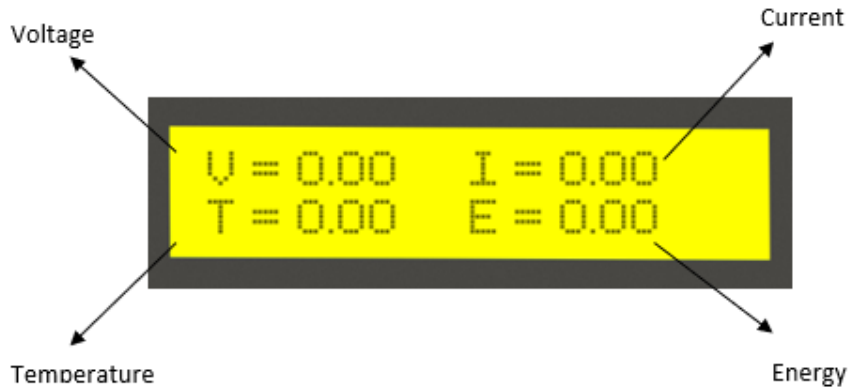

→ After 1 second, the following two LCD screens get switched with each other.

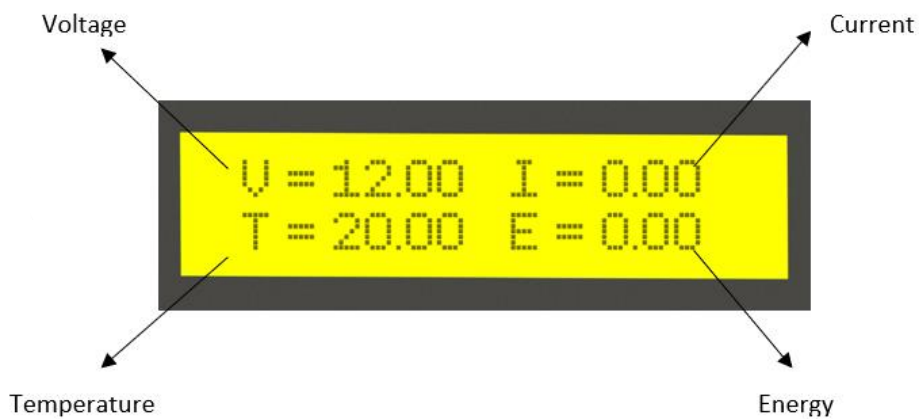
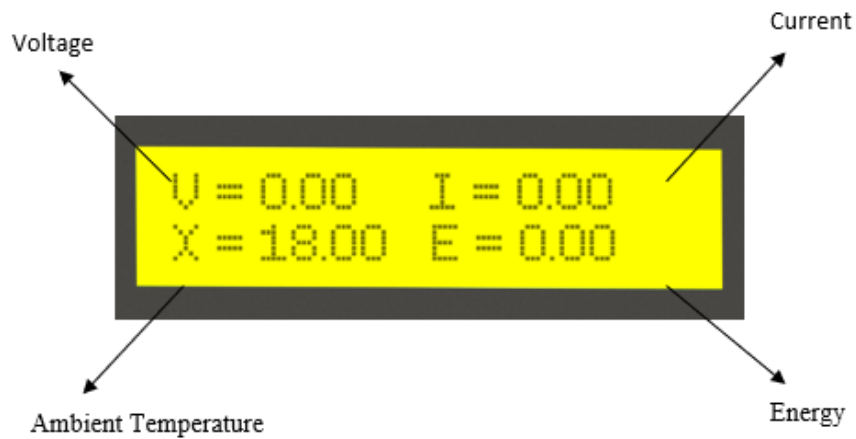

### 3. Fault Reset:

Fault Reset is a push button which is used to make the offset current to zero. It is also used to reset alarm raised during overvoltage, undervoltage, overcurrent and overtemperature faults.

### 4. F12 Terminals:

These are the output terminals of the Module having electronic switch protection that is limited to 100VDC only. F12 terminals are used to connect the load or charger to the Module. There are also positive and negative cables in the jumper cable set. The red one is positive (+), the black one is negative (-).



**Never connect the red cable to the negative terminal of the Module.**

### 3. Module Installation:

#### 3.1 Inspection:

Inspect the shipping carton for visible damage including cracks, dents, deformation and other visible abnormalities prior to unpacking the Module. Document (photograph) any damage and report this to your Reseller as well as to the shipping agent immediately. Remove the Module from the shipping carton and retain the shipping materials until the unit has been inspected and is determined to be operational.

#### 3.2 Safety Gear:

Installation must strictly follow the national safety regulations in compliance with the enclosure, installation, creepage, clearance, casualty, markings and segregation requirements of the end-use application. Installation must be performed by professional installers only. Switch OFF the system and check for hazardous voltages before altering any connection! Sirius Modules must be handled only by qualified and trained personnel. Installation should not exert bending or twisting torque to the Module enclosure.



**Note!**  
**Read the safety Instruction section before installation.**

### 3.3 Unpacking and Contents Check:

Check the contents of the package.

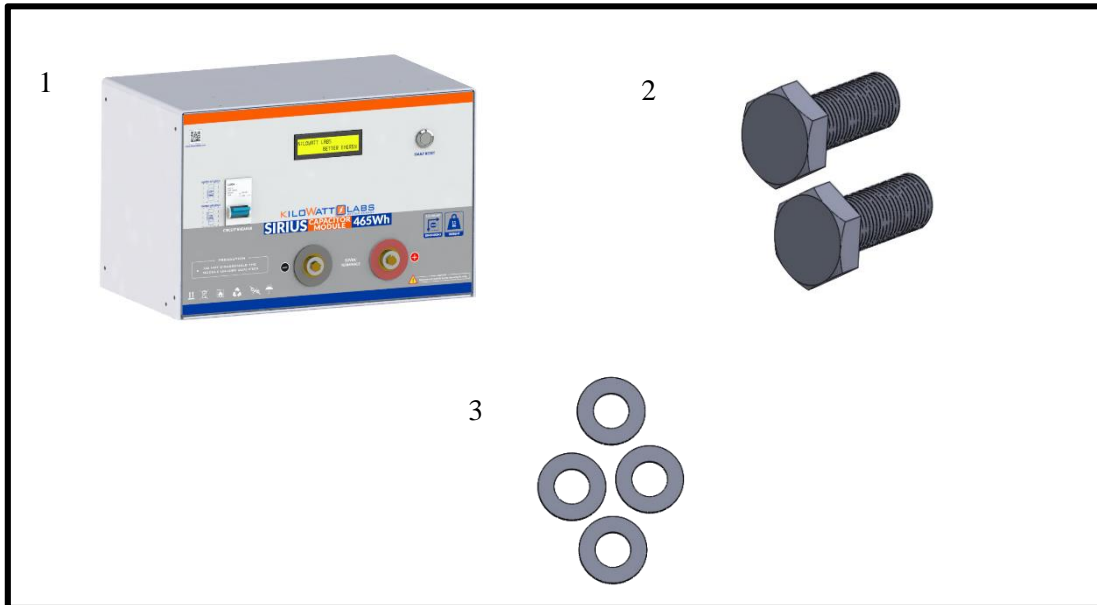

- 1) Sirius Capacitor Module: 465KWh12VDC
- 2) Screws × 2
- 3) Washers × 4

### 4. Operation Procedures:

#### 4.1 Module Configuration:

Follow the steps below to switch ON the Module.

#### Step 1: Connecting the Load:

Connect the F12 terminals of the Module to the load. F12 terminals are shown in picture below:



**Step 2: Module Start-Up:**

1. Turn **ON** the Circuit breaker by pushing the Blue button upwards as shown in the picture below:

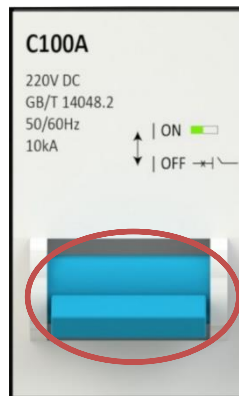

2. The picture below shows that the Module is turned **ON**.

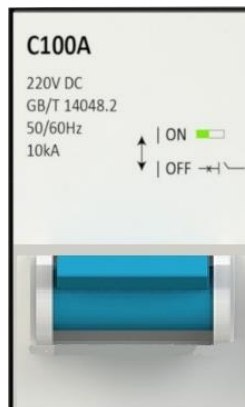

**Step 3: Module Shut-Down:**

1. Turn **OFF** the Module by moving the Circuit breaker button to the **OFF** position.



**Note!**

Always turn **OFF** the Module when not in use because it is Self-Powered. If left **ON**, the self-discharge rate will increase.

**5. Connecting the Module in Parallel or in Series:**

The capacity or voltage of the Module can be increased by connecting them in Parallel or Series combination respectively.

**5.1 Parallel Connection of Sirius Modules:**

Any number of Modules can be connected in parallel.

- **Steps to Connect Modules in Parallel:**

Refer to the parallel combination of the Sirius Modules as shown below and make your connection accordingly.

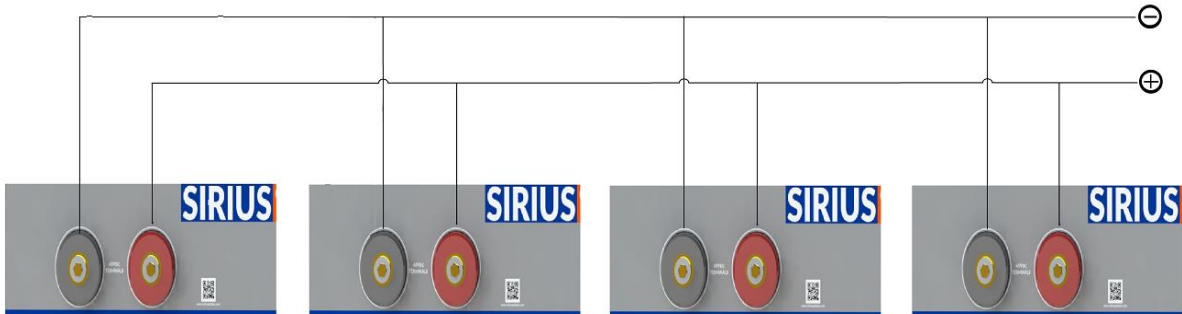

- Connect the positive (+) of the F12 Terminal of all Modules.
- Connect the negative (-) of the F12 Terminal of all Modules.
- Take out the output positive and output negative from the respective common point.



**Caution!**  
Charge all the Modules to 100% SOC or same voltage level before connecting them in Parallel.

## 5.2 Series Connection of Sirius Modules:

A maximum of 35 Modules can be connected in Series with a Module Combiner.

- **Steps to Connect Modules in Series:**

Refer to the Series combination of the Sirius Modules as shown below and make your connection accordingly.

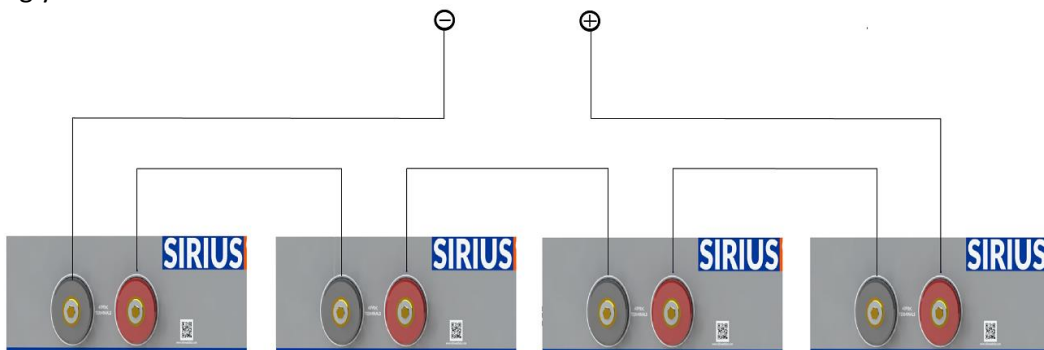

- Connect the positive (+) of the F12 Terminal of the first Module with the negative (-) of the F12

terminal of the next Module.

- Take the Output Negative from first Module and Output Positive from the last Module.





**Caution!**  
Charge all the Modules to 100% SOC or same voltage level before connecting them in Series.









**Note!**  
Modules cannot be connected in series-parallel combination under any circumstance.







### 6. Automatic Safety Shutdown:







The Module will raise alarm under any excessive use conditions in order to prevent damage to itself and to the connected equipment. Specified limits for excessive current, high voltage and low voltage are provided in Module’s technical data sheet.

Alarm	LCD warning	Description
OVER-VOLTAGE		When the Module has an Over-Voltage fault, it means the voltage has increased beyond the cut-off limit of 13.5V. The Module will raise alarm which can be reset by the fault reset button.
UNDER-VOLTAGE		When the Module has an Under-Voltage fault, it means the voltage has reached beyond the cut-off limit of 11V. The Module will give alarm which can be reset by the fault reset button.
OVER-TEMPERATURE (TERMINAL)		When the Module has an Over-Temperature fault, the buzzer alarms, which can be reset by the fault reset button.



OVER-TEMPERATURE (TERMINAL) & OVER-VOLTAGE		When the Module has an Over-Temperature and Over-Voltage fault, the buzzer alarms, which can be reset by the fault reset button.
OVER-TEMPERATURE (TERMINAL) & UNDER-VOLTAGE		When the Module has an Over-Temperature and Under-Voltage fault, the buzzer alarms, which can be reset by the fault reset button.
OVER-TEMPERATURE (CELLS)		When the cells have an Over-Temperature fault, the buzzer alarms, which can be reset by the fault reset button.
OVER-TEMPERATURE (CELLS) & OVER-VOLTAGE		When the Module has an Over-Voltage and cells Over-Temperature fault, the buzzer alarms, which can be reset by the fault reset button.
OVER-TEMPERATURE (CELLS) & UNDER-VOLTAGE		When the Module has an Under-Voltage and cells Over-Temperature fault, the buzzer alarms, which can be reset by the fault reset button.
OVER-TEMPERATURE (CELLS) & OVER-TEMPERATURE (TERMINAL)		When the Module has an Over-Temperature and cells Over-Temperature fault, the buzzer alarms, which can be reset by the fault reset button.
OVER-TEMPERATURE (CELLS) & OVER-TEMPERATURE (TERMINAL) & OVER-VOLTAGE		When the Module has an Over-Temperature, cells Over-Temperature and Over-Voltage fault, the buzzer alarms, which can be reset by the fault reset button.

<p>OVER-TEMPERATURE (CELLS) &amp; OVER-TEMPERATURE (TERMINAL) &amp; UNDER-VOLTAGE</p>		<p>When the Module has an Over-Temperature, cells Over-Temperature and Under-Voltage fault, the buzzer alarms, which can be reset by the fault reset button.</p>
<p>OVER-CURRENT</p>		<p>When the Module has an Over-Current fault, it means the current has increased beyond the cut-off limit of 35A. The Module will raise alarm which can be reset by the fault reset button.</p>
<p>OVER-CURRENT &amp; OVER-VOLTAGE</p>		<p>When the Module has an Over-Current and Over-Voltage fault, the Module will raise alarm which can be reset by the fault reset button.</p>
<p>OVER-CURRENT &amp; UNDER-VOLTAGE</p>		<p>When the Module has an Over-Current and Under-Voltage fault, the Module will raise alarm which can be reset by the fault reset button.</p>
<p>OVER-CURRENT &amp; OVER-TEMPERATURE (TERMINAL)</p>		<p>When the Module has an Over-Current and Over-Temperature fault, the Module will raise alarm which can be reset by the fault reset button.</p>
<p>OVER-CURRENT &amp; OVER-TEMPERATURE (TERMINAL) &amp; OVER-VOLTAGE</p>		<p>When the Module has an Over-Current, Over-Temperature and Over-Voltage fault, the Module will raise alarm which can be reset by the fault reset button.</p>
<p>OVER-CURRENT &amp; OVER-TEMPERATURE (TERMINAL) &amp; UNDER-VOLTAGE</p>		<p>When the Module has an Over-Current, Over-Temperature and Under-Voltage fault, the Module</p>

		will raise alarm which can be reset by the fault reset button.
OVER-CURRENT & OVER-TEMPERATURE (CELLS)		When the Module has an Over-Current and cells Over-Temperature fault, the Module will raise alarm which can be reset by the fault reset button.
OVER-CURRENT & OVER-TEMPERATURE (CELLS) & OVER-VOLTAGE		When the Module has an Over-Current, cells Over-Temperature and Over-Voltage fault, the Module will raise alarm which can be reset by the fault reset button.
OVER-CURRENT & OVER-TEMPERATURE (CELLS) & UNDER-VOLTAGE		When the Module has an Over-Current, cells Over-Temperature and Under-Voltage fault, the Module will raise alarm which can be reset by the fault reset button.
OVER-CURRENT & OVER-TEMPERATURE (CELLS) & OVER-TEMPERATURE (TERMINAL)		When the Module has an Over-Current, Over-Temperature and cells Over-Temperature fault, the Module will raise alarm which can be reset by the fault reset button.
OVER-CURRENT & OVER-TEMPERATURE (CELLS) & OVER-TEMPERATURE (TERMINAL) & OVER-VOLTAGE		When the Module has an Over-Current, Over-Temperature, cells Over-Temperature and Over-Voltage fault, the Module will raise alarm which can be reset by the fault reset button.
OVER-CURRENT & OVER-TEMPERATURE (CELLS) & OVER-TEMPERATURE (TERMINAL) & UNDER-VOLTAGE		When the Module has an Over-Current, Over-Temperature, cells Over-Temperature and under-Voltage fault, the Module will raise alarm which can be reset by the fault reset button.

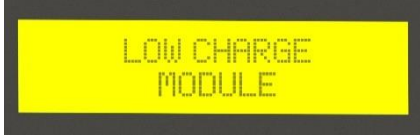
Module Low Charge (Without Load)		When the Module is in standby mode and it reaches the minimum voltage, the LCD will display this message every 10 seconds.
-------------------------------------	---	--

**7. Trouble Shooting:**

Check the indicators on the front panel to determine the state of the Module. A warning state is triggered when a condition, such as voltage, current or temperature, is beyond design limitations. When the Module falls outside prescribed limits, it enters a warning state. When a warning is reported, the Module immediately stops operation.

The possible warning messages are as follows:

Warning Messages	Description	Trouble Shooting
<b>Over-Current</b>	Over-Current occurs when the current goes above 35A or when the Module is short-circuited.	Switch OFF the circuit breaker and check the continuity across the Module terminals to find whether there is a short circuit. In case of a short circuit, check the operating circuitry and clear the short circuit.
<b>Over-Temperature</b>	Over-Temperature occurs when the Module temperature goes above 80°C.	Shut down the Module and check the surrounding temperature and ensure the ambient temperature is less than 80°C. If not leave the Module to cool till the temperature comes below 80°C. Now, turn ON the circuit breaker.
<b>Over-voltage</b>	Over-Voltage occurs when the Module voltage has increased the cut-off limit of 13.5V. In this event, the buzzer alarms which can be reset by fault reset button.	Check the charger’s upper cut-off limit and ensure it is set below 13.5V. The Module becomes operational when the Module’s surface charge is cleared, and the voltage drops below 13.5V.

<b>Under-voltage</b>	Under-Voltage occurs when the Module voltage goes beyond cut-off limit of 11V. In this event, the buzzer alarms which can be reset by fault reset button.	Check for the operating load lower cut-off limit and ensure it is above the lower threshold limit of 11V. The Module becomes operational when the voltage goes above 11V.
----------------------	---	---

**8. Features:**

**8.1 Key Features:**

- Low power consumption.
- Long service life.
- Front panel of Sirius Module has LCD and Fault Reset Button. By using Reset fault Button and LCD user can:
  - Read Terminal Voltage, Terminal Current, Terminal Temperature and Ambient Temperature.
  - Recalibrating Current Measurement by configuring zero current values.
  - Snooze alarms in case of repeating Module alarms.
- Sirius Module has efficient relay that buzzer alarm in case of:
  - High Voltage
  - Low Voltage
  - High Current
  - High Module Temperature

**9. Shelf Life:**

Shelf life is the life of the Module in years from the date it is manufactured to the time it is first operated. The shelf life of supercapacitor cell is 10 years.

**10. Maintenance:**

The Sirius Module does not require periodic maintenance.

**11. Disposal:**

Dispose according to local regulation.